

## Data sheet | Item number: 769-671

THT male header; 1.0 x 1.0 mm solder pin; straight; Pin spacing 5 mm; 11-pole



769-671



RoHS  Compliant

[BOMcheck.net](https://www.bomcheck.net)

Color: ■

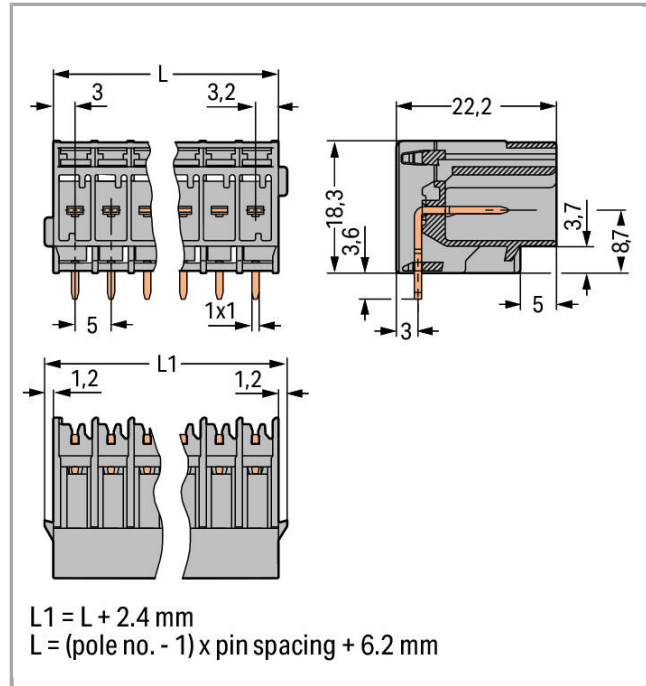

### Data

#### Electrical data

#### Ratings per IEC/EN 60664-1

Rated voltage (III / 3)	250 V
Rated impulse voltage (III / 3)	4 kV
Rated voltage (III / 2)	500 V
Rated impulse voltage (III / 2)	4 kV
Rated current	32 A

#### Connection data

No. of poles	11
Total number of potentials	11
Number of levels	1

## Geometrical Data

Pin spacing	5 mm / 0.197 inch
Width	58.6 mm / 2.307 inch
Height from the surface	18.3 mm / 0.72 inch
Depth	22.2 mm / 0.874 inch

## Plug connection

Contact type (pluggable connector)	Male connector/plug
Connector connection type	for PCBs
Mismating protection	No
Mating direction to the PCB	0°

## PCB contact

PCB contact	THT
-------------	-----

## Material Data

Color	gray
Insulating material	Polyamide 66 (PA 66)
Fire load	0.235 MJ
Weight	11.812 g

## Commercial data



Product Group	18 (X-COM-System)
Country of origin	DE
GTIN	4017332602488
Customs Tariff No.	85366990990

## Approvals / Certificates



### Country specific Approvals

Logo	Approval	Additional Approval Text	Certificate name
	CCA DEKRA Certification B.V.	EN 60947	NTR NL-7626
	CCA DEKRA Certification B.V.	IEC 61984	NL-47799
	CCA DEKRA Certification B.V.	EN 61984	2190419.02



	CSA DEKRA Certification B.V.	C22.2 No. 158	1101144
	KEMA/KEUR DEKRA Certification B.V.	EN 60947	2190419.01















UL-Approvals















Logo	Approval	Additional Approval Text	Certificate name
	UR Underwriters Laboratories Inc.	UL 1977	E45171
	UR Underwriters Laboratories Inc.	UL 1059	E45172

Compatible products

Female plug

	Item no.: 769-101 1-conductor female plug; 4 mm <sup>2</sup> ; 1-pole		769-101
	Item no.: 769-102 1-conductor female plug; 4 mm <sup>2</sup> ; 2-pole		769-102
	Item no.: 769-102/000-036 1-conductor female plug; 4 mm <sup>2</sup> ; 2-pole	/000-036	769-102
	Item no.: 769-102/000-037 1-conductor female plug; 4 mm <sup>2</sup> ; 2-pole	/000-037	769-102
	Item no.: 769-103 1-conductor female plug; 4 mm <sup>2</sup> ; 3-pole		769-103
	Item no.: 769-103/000-036 1-conductor female plug; 4 mm <sup>2</sup> ; 3-pole	/000-036	769-103

	<b>Item no.: 769-103/000-037</b> 1-conductor female plug; 4 mm <sup>2</sup> ; 3-pole	/000-037	769-103
	<b>Item no.: 769-103/000-038</b> 1-conductor female plug; 4 mm <sup>2</sup> ; 3-pole	/000-038	769-103
	<b>Item no.: 769-103/000-039</b> 1-conductor female plug; 4 mm <sup>2</sup> ; 3-pole	/000-039	769-103
	<b>Item no.: 769-104</b> 1-conductor female plug; 4 mm <sup>2</sup> ; 4-pole		769-104
	<b>Item no.: 769-104/000-036</b> 1-conductor female plug; 4 mm <sup>2</sup> ; 4-pole	/000-036	769-104
	<b>Item no.: 769-104/000-037</b> 1-conductor female plug; 4 mm <sup>2</sup> ; 4-pole	/000-037	769-104
	<b>Item no.: 769-104/000-038</b> 1-conductor female plug; 4 mm <sup>2</sup> ; 4-pole	/000-038	769-104
	<b>Item no.: 769-104/000-039</b> 1-conductor female plug; 4 mm <sup>2</sup> ; 4-pole	/000-039	769-104
	<b>Item no.: 769-105</b> 1-conductor female plug; 4 mm <sup>2</sup> ; 5-pole		769-105
	<b>Item no.: 769-105/000-036</b> 1-conductor female plug; 4 mm <sup>2</sup> ; 5-pole	/000-036	769-105
	<b>Item no.: 769-105/000-037</b> 1-conductor female plug; 4 mm <sup>2</sup> ; 5-pole	/000-037	769-105
	<b>Item no.: 769-105/000-038</b> 1-conductor female plug; 4 mm <sup>2</sup> ; 5-pole	/000-038	769-105
	<b>Item no.: 769-105/000-039</b> 1-conductor female plug; 4 mm <sup>2</sup> ; 5-pole	/000-039	769-105
	<b>Item no.: 769-106</b> 1-conductor female plug; 4 mm <sup>2</sup> ; 6-pole		769-106
	<b>Item no.: 769-106/000-006</b> 1-conductor female plug; 4 mm <sup>2</sup> ; 6-pole	/000-006	769-106

	<b>Item no.: 769-106/000-036</b> 1-conductor female plug; 4 mm <sup>2</sup> ; 6-pole	769-106 /000-036
	<b>Item no.: 769-106/000-037</b> 1-conductor female plug; 4 mm <sup>2</sup> ; 6-pole	769-106 /000-037
	<b>Item no.: 769-106/000-038</b> 1-conductor female plug; 4 mm <sup>2</sup> ; 6-pole	769-106 /000-038
	<b>Item no.: 769-106/000-039</b> 1-conductor female plug; 4 mm <sup>2</sup> ; 6-pole	769-106 /000-039
	<b>Item no.: 769-107</b> 1-conductor female plug; 4 mm <sup>2</sup> ; 7-pole	769-107
	<b>Item no.: 769-107/000-036</b> 1-conductor female plug; 4 mm <sup>2</sup> ; 7-pole	769-107 /000-036
	<b>Item no.: 769-107/000-037</b> 1-conductor female plug; 4 mm <sup>2</sup> ; 7-pole	769-107 /000-037
	<b>Item no.: 769-107/000-038</b> 1-conductor female plug; 4 mm <sup>2</sup> ; 7-pole	769-107 /000-038
	<b>Item no.: 769-107/000-039</b> 1-conductor female plug; 4 mm <sup>2</sup> ; 7-pole	769-107 /000-039
	<b>Item no.: 769-108</b> 1-conductor female plug; 4 mm <sup>2</sup> ; 8-pole	769-108
	<b>Item no.: 769-108/000-036</b> 1-conductor female plug; 4 mm <sup>2</sup> ; 8-pole	769-108 /000-036
	<b>Item no.: 769-108/000-037</b> 1-conductor female plug; 4 mm <sup>2</sup> ; 8-pole	769-108 /000-037
	<b>Item no.: 769-108/000-038</b> 1-conductor female plug; 4 mm <sup>2</sup> ; 8-pole	769-108 /000-038
	<b>Item no.: 769-108/000-039</b> 1-conductor female plug; 4 mm <sup>2</sup> ; 8-pole	769-108 /000-039
	<b>Item no.: 769-109</b> 1-conductor female plug; 4 mm <sup>2</sup> ; 9-pole	769-109
	<b>Item no.: 769-109/000-036</b> 1-conductor female plug; 4 mm <sup>2</sup> ; 9-pole	769-109 /000-036

**Item no.: 769-109/000-037**1-conductor female plug; 4 mm<sup>2</sup>; 9-pole

/000-037

769-109

**Item no.: 769-109/000-038**1-conductor female plug; 4 mm<sup>2</sup>; 9-pole

/000-038

769-109

**Item no.: 769-109/000-039**1-conductor female plug; 4 mm<sup>2</sup>; 9-pole

/000-039

769-109

**Item no.: 769-110**1-conductor female plug; 4 mm<sup>2</sup>; 10-pole

769-110

**Item no.: 769-110/000-036**1-conductor female plug; 4 mm<sup>2</sup>; 10-pole

/000-036

769-110

**Item no.: 769-110/000-037**1-conductor female plug; 4 mm<sup>2</sup>; 10-pole

/000-037

769-110

**Item no.: 769-110/000-038**1-conductor female plug; 4 mm<sup>2</sup>; 10-pole

/000-038

769-110

**Item no.: 769-110/000-039**1-conductor female plug; 4 mm<sup>2</sup>; 10-pole

/000-039

769-110

**Item no.: 769-111**1-conductor female plug; 4 mm<sup>2</sup>; 11-pole

769-111

**Item no.: 769-111/000-036**1-conductor female plug; 4 mm<sup>2</sup>; 11-pole

/000-036

769-111

**Item no.: 769-111/000-037**1-conductor female plug; 4 mm<sup>2</sup>; 11-pole

/000-037

769-111

**Item no.: 769-111/000-038**1-conductor female plug; 4 mm<sup>2</sup>; 11-pole

/000-038

769-111

**Item no.: 769-111/000-039**1-conductor female plug; 4 mm<sup>2</sup>; 11-pole

/000-039

769-111

**Item no.: 769-111/021-000**1-conductor female plug; Locking lever; 4 mm<sup>2</sup>; 11-pole

/021-000

769-111

**Item no.: 769-112**1-conductor female plug; 4 mm<sup>2</sup>; 12-pole

769-112

**Item no.: 769-112/000-036**1-conductor female plug; 4 mm<sup>2</sup>; 12-pole

/000-036

769-112

**Item no.: 769-112/000-037**1-conductor female plug; 4 mm<sup>2</sup>; 12-pole

/000-037

769-112

**Item no.: 769-112/000-038**1-conductor female plug; 4 mm<sup>2</sup>; 12-pole

/000-038

769-112

**Item no.: 769-112/000-039**1-conductor female plug; 4 mm<sup>2</sup>; 12-pole

/000-039

769-112

**Item no.: 769-113**1-conductor female plug; 4 mm<sup>2</sup>; 13-pole

769-113

**Item no.: 769-113/000-036**1-conductor female plug; 4 mm<sup>2</sup>; 13-pole

/000-036

769-113

**Item no.: 769-113/000-037**1-conductor female plug; 4 mm<sup>2</sup>; 13-pole

/000-037

769-113

**Item no.: 769-113/000-038**1-conductor female plug; 4 mm<sup>2</sup>; 13-pole

/000-038

769-113

**Item no.: 769-113/000-039**1-conductor female plug; 4 mm<sup>2</sup>; 13-pole

/000-039

769-113

**Item no.: 769-114**1-conductor female plug; 4 mm<sup>2</sup>; 14-pole

769-114

**Item no.: 769-114/000-036**1-conductor female plug; 4 mm<sup>2</sup>; 14-pole

/000-036

769-114

**Item no.: 769-114/000-037**1-conductor female plug; 4 mm<sup>2</sup>; 14-pole

/000-037

769-114

**Item no.: 769-114/000-038**1-conductor female plug; 4 mm<sup>2</sup>; 14-pole

/000-038

769-114

**Item no.: 769-114/000-039**1-conductor female plug; 4 mm<sup>2</sup>; 14-pole

/000-039

769-114

**Item no.: 769-115**1-conductor female plug; 4 mm<sup>2</sup>; 15-pole

769-115



**Item no.: 769-115/000-036**  
1-conductor female plug; 4 mm<sup>2</sup>; 15-pole

/000-036

769-115



**Item no.: 769-115/000-037**  
1-conductor female plug; 4 mm<sup>2</sup>; 15-pole

/000-037

769-115



**Item no.: 769-115/000-038**  
1-conductor female plug; 4 mm<sup>2</sup>; 15-pole

/000-038

769-115



**Item no.: 769-115/000-039**  
1-conductor female plug; 4 mm<sup>2</sup>; 15-pole

/000-039

769-115



**Item no.: 769-121**  
2-conductor female connector; 4 mm<sup>2</sup>; 1-pole

769-121



**Item no.: 769-122**  
2-conductor female connector; 4 mm<sup>2</sup>; 2-pole

769-122



**Item no.: 769-123**  
2-conductor female connector; 4 mm<sup>2</sup>; 3-pole

769-123



**Item no.: 769-124**  
2-conductor female connector; 4 mm<sup>2</sup>; 4-pole

769-124



**Item no.: 769-125**  
2-conductor female connector; 4 mm<sup>2</sup>; 5-pole

769-125



**Item no.: 769-126**  
2-conductor female connector; 4 mm<sup>2</sup>; 6-pole

769-126



**Item no.: 769-127**  
2-conductor female connector; 4 mm<sup>2</sup>; 7-pole

769-127



**Item no.: 769-128**  
2-conductor female connector; 4 mm<sup>2</sup>; 8-pole

769-128



**Item no.: 769-129**  
2-conductor female connector; 4 mm<sup>2</sup>; 9-pole

769-129



**Item no.: 769-130**  
2-conductor female connector; 4 mm<sup>2</sup>; 10-pole

769-130



**Item no.: 769-131**  
2-conductor female connector; 4 mm<sup>2</sup>; 11-pole

769-131



**Item no.: 769-132**  
2-conductor female connector; 4 mm<sup>2</sup>; 12-pole

769-132



**Item no.: 769-133**  
2-conductor female connector; 4 mm<sup>2</sup>; 13-pole

769-133



**Item no.: 769-134**  
2-conductor female connector; 4 mm<sup>2</sup>; 14-pole

769-134



**Item no.: 769-135**  
2-conductor female connector; 4 mm<sup>2</sup>; 15-pole

769-135

## Coding



**Item no.: 769-435**  
Coding pin; for coding of female plugs; for carrier terminal blocks / male connectors

769-435

## ferrule



**Item no.: 216-101**  
Ferrule; Sleeve for 0.5 mm<sup>2</sup> / AWG 22; uninsulated; electro-tin plated

216-101



**Item no.: 216-102**  
Ferrule; Sleeve for 0.75 mm<sup>2</sup> / AWG 20; uninsulated; electro-tin plated

216-102



**Item no.: 216-103**  
Ferrule; Sleeve for 1 mm<sup>2</sup> / AWG 18; uninsulated; electro-tin plated

216-103



**Item no.: 216-104**  
Ferrule; Sleeve for 1.5 mm<sup>2</sup> / AWG 16; uninsulated; electro-tin plated

216-104



**Item no.: 216-201**  
Ferrule; Sleeve for 0.5 mm<sup>2</sup> / 20 AWG; insulated; electro-tin plated

216-201



**Item no.: 216-202**  
Ferrule; Sleeve for 0.75 mm<sup>2</sup> / 18 AWG; insulated; electro-tin plated

216-202



**Item no.: 216-203**  
Ferrule; Sleeve for 1 mm<sup>2</sup> / AWG 18; insulated; electro-tin plated

216-203



**Item no.: 216-204**  
Ferrule; Sleeve for 1.5 mm<sup>2</sup> / AWG 16; insulated; electro-tin plated

216-204



**Item no.: 216-206**  
Ferrule; Sleeve for 2.5 mm<sup>2</sup> / AWG 14; insulated; electro-tin plated

216-206

**Item no.: 216-301**  
Ferrule; Sleeve for 0.25 mm<sup>2</sup> / AWG 24; insulated; electro-tin plated

216-301



**Item no.: 216-302**  
Ferrule; Sleeve for 0.34 mm<sup>2</sup> / 22 AWG; insulated; electro-tin plated

216-302

## Marking accessories



**Item no.: 210-831**  
Marking strips; on reel; 2.3 mm wide; plain; Self-adhesive

210-831



**Item no.: 210-832**  
Marking strips; on reel; 3 mm wide; plain; Self-adhesive

210-832



**Item no.: 210-833**  
Marking strips; on reel; 6 mm wide; plain; Self-adhesive

210-833



**Item no.: 210-834**  
Marking strips; on reel; 5 mm wide; plain; Self-adhesive

210-834



Downloads

Documentation

Bid Text

---

769-671	doc 25.6 kB	Download
---------	----------------	----------

---

CAD/CAE - Smart Data

CAD data

---

3D Download 769-671	URL	Download
---------------------	-----	----------

---

Product family

**X-COM**

[Learn more about the product family.](#)

[Show all products from the family](#)

Subject to changes.

---